

Solaris
10700



Inquadra il **qr code** per visualizzare la
scheda di installazione e manutenzione
*Scan the qr code to read the installation
and maintenance page*



Inquadra il **qr code** per visualizzare la
scheda tecnica
*Scan the qr code to read the technical
features page*



Solaris 10700

Cabina curva due battenti
Cabin curve with twin pivot doors

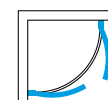

cristallo temprato 6 mm / tempered thick glass 6 mm



TR SA SC

finiture standard / standard finishes

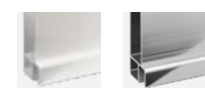

32 33

finiture speciali / special finishes



11 12 13 14 15 16 17 18

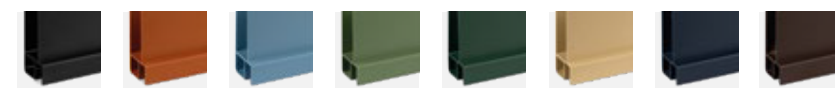

19 20 22 24 26 27 28 29

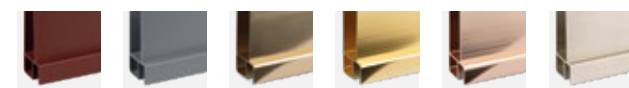

30 31 34 35 36 41

finiture speciali extra / extra special finishes



40 53 55 56



articolo article	estensione accoppiata - EST coupled extension - EST	estensione da imballo - A package extension - A	entrata (B) entry (B)	ingombro (C) encumbrance (C)	Vetro / glass		
					TR	SA	SC
10701	-	75-76,5	94	53	profili standard: Argento brill / Verniciato bianco standard profiles: polished silver (AB) / white varnished (VB)		
10702	-	85-86,5	109	63			

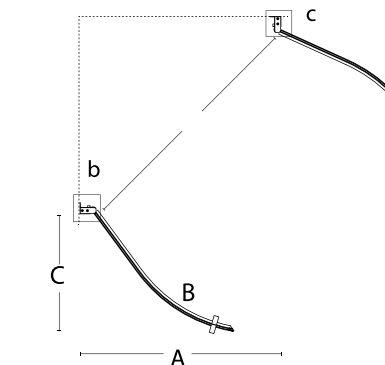
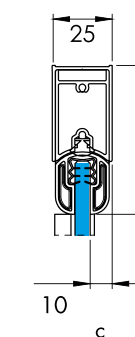
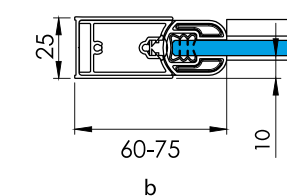
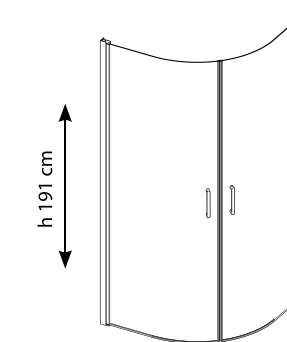

NOTE E SUPPLEMENTI / Notes and extras

Tempi di produzione 2 settimane / 2 weeks required to manufacture

Finiture speciali: **+25%**
Finiture speciali extra: **+50%**

Dimensioni speciali: **+25%**

Finiture speciali + dimensioni speciali: **+35%**
Finiture speciali extra + dimensioni speciali: **+60%**

Trattamento anticalcare:

Special finishes: **+25%**
Extra special finishes: **+50%**

Special size: **+25%**

Special finishes + Special size: **+35%**
Extra special finishes + Special size: **+60%**

Anti-limescale treatment:

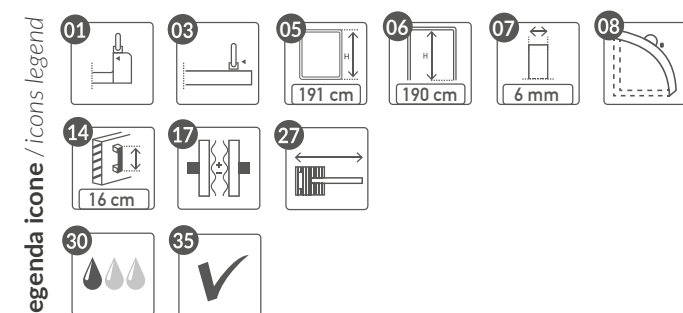

legenda icone / icons legend