

Solaris con
paretina
11400



Inquadra il **qr code** per visualizzare la
scheda di installazione e manutenzione
*Scan the qr code to read the installation
and maintenance page*



Inquadra il **qr code** per visualizzare la
scheda tecnica
*Scan the qr code to read the technical
features page*



Solaris con paretina 11400

Porta saloon con due lati fissi in linea
Saloon doors with two in-line small panels

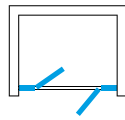

cristallo temprato 6 mm / tempered thick glass 6 mm



finiture standard / standard finishes

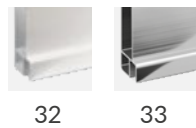

finiture speciali / special finishes

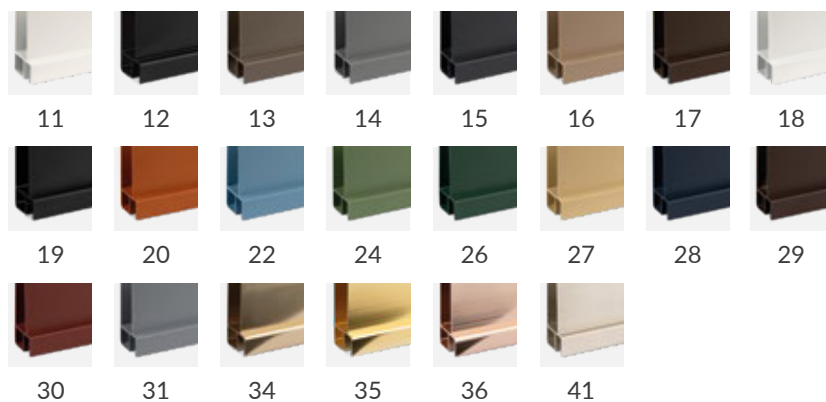

finiture speciali extra / extra special finishes

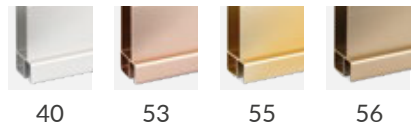

Vetro / glass

articolo article	estensione accoppiata - EST coupled extension - EST	estensione da imballo - A package extension - A	entrata (B) entry (B)	ingombro (C) encumbrance (C)	ingombro (D) encumbrance (D)	Vetro / glass	
						TR	SA SC - FU - BR
11401	-	102,5-107,5	50	24	27	profili standard: Argento brill / Verniciato bianco standard profiles: polished silver (AB) / white varnished (VB)	
11402	-	107,5-112,5	55	27	27		
11403	-	112,5-117,5	60	29	27		
11404	-	117,5-122,5	65	32	27		
11405	-	127,5-132,5	70	34	29		
11406	-	132,5-137,5	75	37	29		
11407	-	137,5-142,5	80	40	29		
11408	-	142,5-147,5	85	42	29		
11409	-	147,5-152,5	90	44	29		
11410	-	152,5-157,5	95	47	29		
11411	-	157,5-162,5	100	50	29		

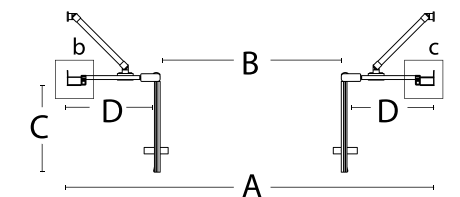
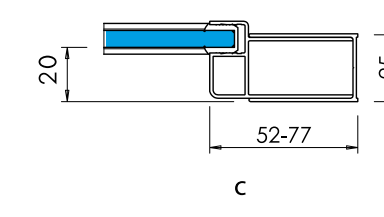
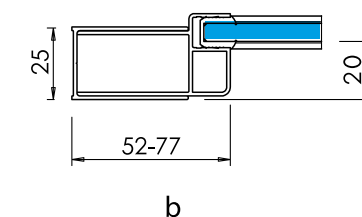
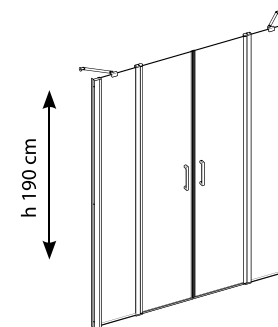

NOTE E SUPPLEMENTI / Notes and extras

Tempi di produzione 2 settimane / 2 weeks required to manufacture

Finiture speciali: **+25%**
Finiture speciali extra: **+50%**

Dimensioni speciali: **+25%**

Finiture speciali + dimensioni speciali: **+35%**
Finiture speciali extra + dimensioni speciali: **+60%**

Trattamento anticalcare:

Special finishes: **+25%**
Extra special finishes: **+50%**

Special size: **+25%**

Special finishes + Special size: **+35%**
Extra special finishes + Special size: **+60%**

Anti-limescale treatment:

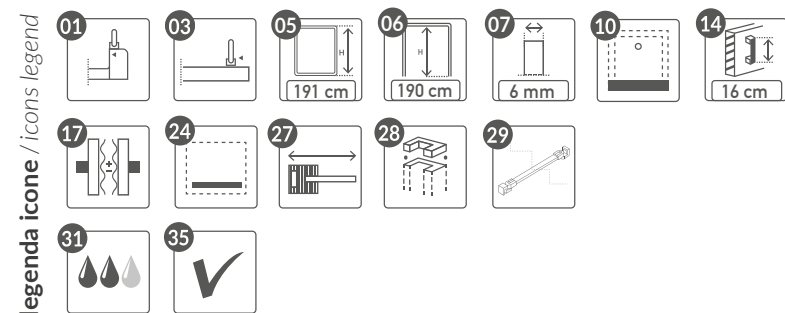

legenda icone / icons legend