

Solaris con
paretina
11800 + 10900



Inquadra il **qr code** per visualizzare la
scheda di installazione e manutenzione
*Scan the qr code to read the installation
and maintenance page*



Inquadra il **qr code** per visualizzare la
scheda tecnica
*Scan the qr code to read the technical
features page*



Solaris con paretina

11800 + 10900

Porta da abbinare a fisso con chiusura magnetica
Door to combine with fix panel with magnetic closing

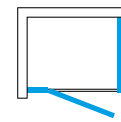

cristallo temprato 6 mm / tempered thick glass 6 mm



finiture standard / standard finishes

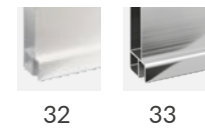

finiture speciali / special finishes

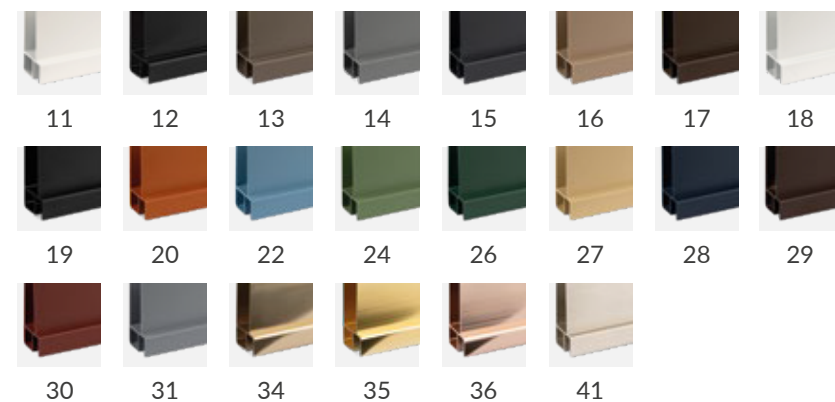

finiture speciali extra / extra special finishes

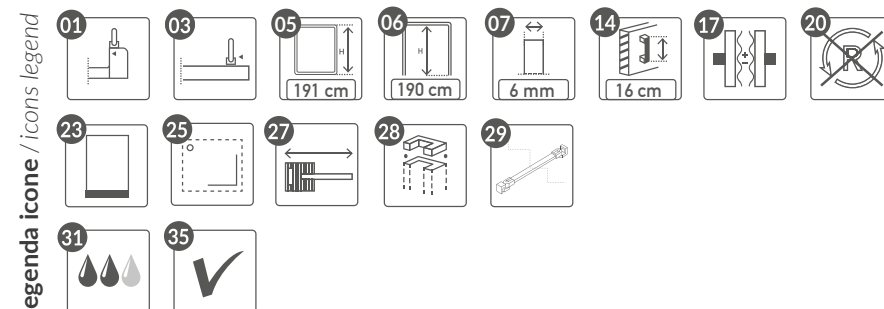
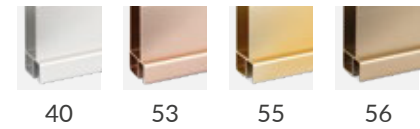

		Vetro / glass					TR SA SC - FU - BR		
art. (SX) art. (SX)	art. (DX) art. (DX)	estensione accoppiata - EST coupled extension - EST	estensione da imballo - A package extension - A	entrata (B) entry (B)	ingombro (C) encumbrance (C)	ingombro (D) encumbrance (D)	profili standard: Argento brill / Verniciato bianco standard11807		
11801S	11801D	67,5-70	65,5-68	40	40	26			
11802S	11802D	70,5-73	68,5-71	42	42	26			
11803S	11803D	72,5-75	70,5-73	45	45	26			
11804S	11804D	77,5-80	75,5-78	45	45	31			
11805S	11805D	87,5-90	85,5-88	55	55	31			
11806S	11806D	97,5-100	95,5-98	55	55	41			
11807S	11807D	117,5-120	115,5-118	70	70	46			

In fase d'ordine specificare il verso riferendosi al profilo di fissaggio a muro, su vetro fisso / When ordering indicate direction referring to the wall-mounted profile, on the fixed glass



		Vetro / glass					TR SA SC - FU - BR		
articolo article	estensione accoppiata - EST coupled extension - EST	estensione da imballo - A package extension - A	entrata (B) entry (B)	ingombro (C) encumbrance (C)	ingombro (D) encumbrance (D)	profili standard: Argento brill / Verniciato bianco standard profiles: polished silver (AB) / white varnished (VB)			
10901	67-69,5	65-67,5	-	-	-				
10902	70-72,5	68-70,5	-	-	-				
10903	73-75,5	71-73,5	-	-	-				
10904	77-79,5	75-77,5	-	-	-				
10905	87-89,5	85-87,5	-	-	-				
10906	97-99,5	95-97,5	-	-	-				
10907	117-119,5	115-117,5	-	-	-				

PRIMA DI SCEGLIERE IL BOX DOCCIA, SEGUI LE INDICAZIONI PER IL CORRETTO RILIEVO DELLE MISURE A PAGINA 21 FIGURA 4B

Before choosing the shower enclosure, read the indications for the correct measurement on page 21 figure 4B

- Verifica la giusta estensibilità del tuo box doccia
L'estensibilità (EST) si misura dal muro all'elemento più distante.
- Check the right extensibility of your shower enclosure.
Extensibility (EST) is measured from the wall to the farthest element

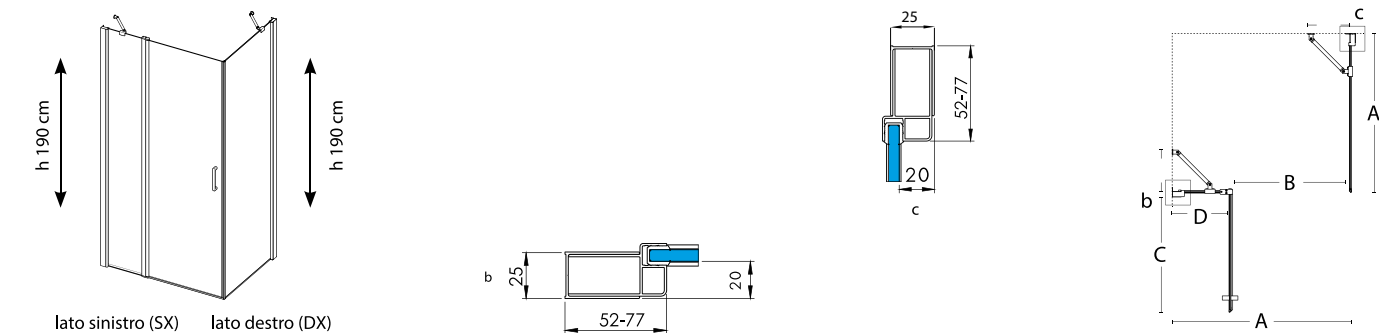
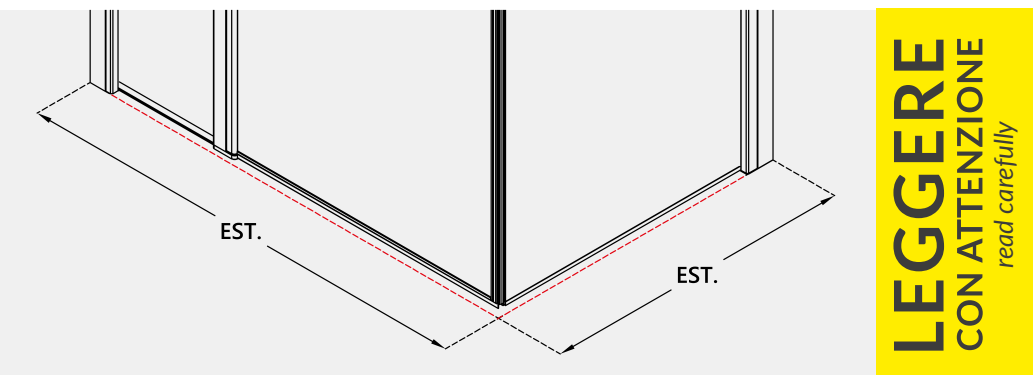

NOTE E SUPPLEMENTI / Notes and extras

Finiture speciali: **+25%**
Finiture speciali extra: **+50%**
Dimensioni speciali: **+25%**
Finiture speciali + dimensioni speciali: **+35%**
Finiture speciali extra + dimensioni speciali: **+60%**
Trattamento anticalcare: per 1 lato

Tempi di produzione 2 settimane / 2 weeks required to manufacture

Special finishes: **+25%**
Extra special finishes: **+50%**
Special size: **+25%**
Special finishes + Special size: **+35%**
Extra special finishes + Special size: **+60%**
Anti-limescale treatment: for 1 side