



Astra
80400



Inquadra il **qr code** per visualizzare la
scheda di installazione e manutenzione
*Scan the qr code to read the installation
and maintenance page*



Inquadra il **qr code** per visualizzare la
scheda tecnica
*Scan the qr code to read the technical
features page*

Astra 80400

Porta saloon
Saloon door

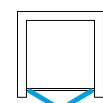

cristallo temprato 8 mm / tempered thick glass 8 mm



finiture standard / standard finishes

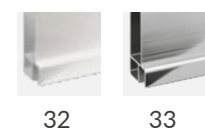

finiture speciali / special finishes

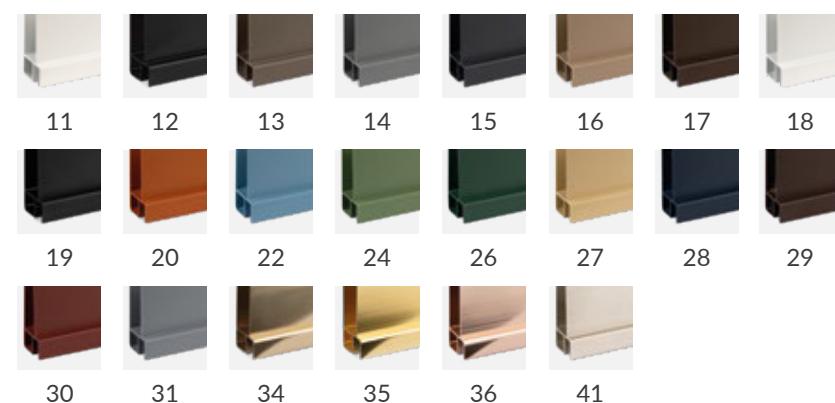

finiture speciali extra / extra special finishes

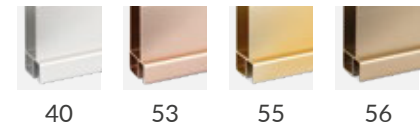

articolo article	estensione accoppiata - EST coupled extension - EST	estensione da imballo - A package extension - A	entrata (B) entry (B)	ingombro (C) encumbrance (C)	Vetro / glass	
					TR	FU - BR
80401	-	67-71	36	18		
80402	-	77-81	46	23		
80403	-	87-91	56	28		
80404	-	97-101	66	33		
80405	-	127-131	96	48		
80406	-	137-141	106	53		
80407	-	147-151	116	58		

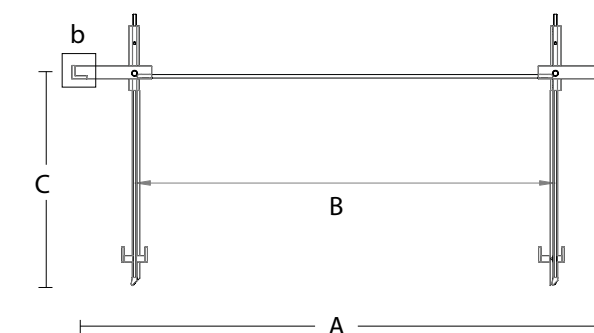
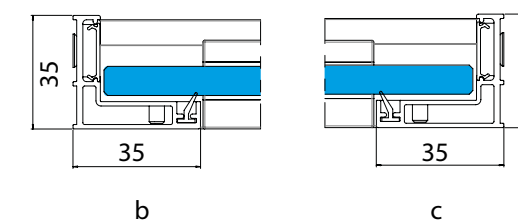
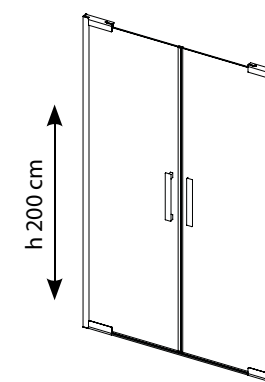

NOTE E SUPPLEMENTI / Notes and extras

Tempi di produzione 2 settimane / 2 weeks required to manufacture

Finiture speciali: **+25%**
Finiture speciali extra: **+50%**

Dimensioni speciali: **+25%**

Finiture speciali + dimensioni speciali: **+35%**
Finiture speciali extra + dimensioni speciali: **+60%**

Trattamento anticalcare:

Special finishes: **+25%**
Extra special finishes: **+50%**

Special size: **+25%**

Special finishes + Special size: **+35%**
Extra special finishes + Special size: **+60%**

Anti-limescale treatment: for 1 side

